

Installation Instructions and Service Manual

“Raptor” Model 145

Actuator for Trailer Brakes

14,500 lbs Capacity

Part #70400D - Drum Brake Ready

**Part #70400 - Disc Brake Ready
W/Solenoid Installed**

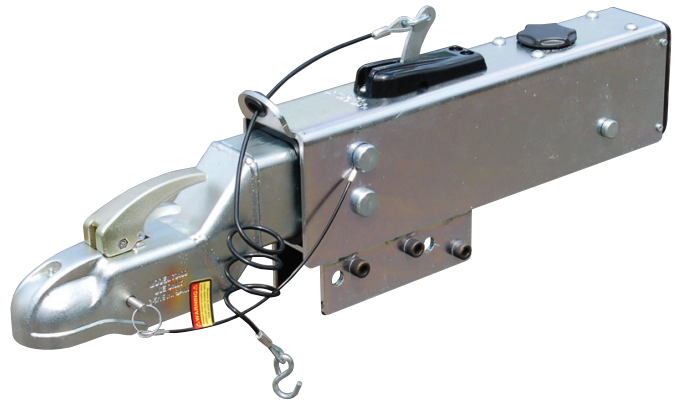

IMPORTANT: READ AND UNDERSTAND THE ENTIRE INSTRUCTION/ASSEMBLY PROCEDURE BEFORE INSTALLING YOUR BRAKES AND ACTUATOR.

The Model 145 works by the “surge” or “push” of the trailer toward the tow vehicle. This automatically synchronizes the trailer brakes with the brakes on the tow vehicle. When the trailer pushes against the tow vehicle, the actuator telescopes together and applies the force to the master cylinder, supplying hydraulic pressure to the brakes. The built in sealed and independent dampening shock absorber controls the telescoping shock against the hitch.

Be sure to comply with regulations for brakes in your state. Brake laws sometimes are minimum standards and you may wish to add additional brakes to your trailer to meet minimum Gross Vehicle Weight Ratings (G.V.W.R.). Note: G.V.W.R. is the Gross Vehicle Weight Rating which includes the trailer and the load weight as a Total Gross Weight.

Read your tow vehicle owner’s manual on towing capacity and other towing recommendations before installing brakes or this actuator.

The Model 145 Actuator is completely assembled and ready to bolt into place (Tongue sizes: 3”x 4” & 3”x 5”, 9 ga. min.).

1. Bolt the actuator to the tongue-using grade 5 bolts 5/8 inch in diameter, 4 inches long. Attachment strength should equal or exceed 1-1/2 times trailer G.V.W.R.
2. Hydraulic brake lines should be installed on the trailer as described in the installation manual supplied with the brakes. Note: Some disc brakes require the use of flexible brake lines at the connection POINT on the brake caliper. Follow brake manufacturer instructions.
3. Use only DOT-3 brake fluid in the Model 145 actuator. Use a pressure type brake bleeder to bleed brakes. (This type of brake bleeder is available at your local automotive parts supply store.) Follow manufacturer’s directions. Or, manually bleed the brakes using a heavy-duty flat blade screwdriver. Insert the screwdriver and use a pumping action to activate the master cylinder in order to bleed the brakes. See page 4 for more details.
4. To bleed master cylinder and brakes, install bleeder hose on first wheel cylinder to be bled; if tandem axle trailer, bleed farthest axle first, and the farthest brake on that axle first. Use a loose end of hose from the bleeder valve submerged in a clear container of brake fluid to observe bubbling (hose must be submerged into clean brake fluid to keep air from traveling back into the brake cylinder). Loosen the bleeder screw located in the wheel cylinder one turn; the system is now open to the atmosphere. The bleeding operation for that brake is complete when bubbling stops. Be sure to tighten bleeder screw securely. Each wheel cylinder must be bled until all air is out of the lines. Replenish the brake fluid during the bleeding process so the level does not fall below half full level in the master cylinder reservoir. When bleeding and testing is completed, make sure master cylinder is filled to approximately 3/8” below the top of the reservoir and filler cap is securely in place.
5. Check with your state motor vehicle department for laws concerning minimum trailer brake requirements. Some states may require brakes on all axles.
6. Road test trailer a short distance to activate the actuator several times. Check fluid level again. Remember, low brake fluid levels will result in reduced braking or no braking at all.
7. When testing is completed, make sure master cylinder is filled to approximately 3/8” below the top of the reservoir and filler cap is securely in place. Road test again to make sure brakes work properly.

Instruction #08161

TIE DOWN ENGINEERING • 255 Villanova Drive SW • Atlanta, GA 30336
www.tiedown.com (404) 344-0000 Fax (404) 349-0401



050412, B1245

RATED CAPACITY: Maximum Actuator Capacity: 14,500 lbs. Gross Load; 1450 lbs. maximum tongue load; minimum tongue weight is 5% of G.V.W.R.

The actual in-service rating is limited to that of the ball and hitch or the least rated component on the tow vehicle or trailer being used or the trailer manufacturer's G.V.W.R. shown on the certification label, whichever is lower (Note: G.V.W.R. is the Gross Vehicle Weight Rating which includes the trailer and the load weight as a Total Gross Weight).

HITCHING TRAILER

1. The vehicle, towing hitch and ball must have a rating equal to or greater than trailer G.V.W.R.
2. Model 145 will accept 2-5/16" trailer hitch balls with a 14,500# capacity only. Trailer balls larger than 2-5/16" or out of round will not fit the coupler or may result in coupler failure. Balls smaller than 2-5/16" can cause shock loading and sudden disconnection. Make certain ball latch is in correct position to retain the hitch ball. Push latch lever down until safety latch engages the hitch ball. Always insert safety pin into forward hole as a safety lock for the hitch ball coupler prior to towing. Do not tow trailer if coupler is damaged.
3. Connect safety cables or chains using crossed pattern under tongue, or follow trailer manufacturer's directions.
4. Connect actuator breakaway cable S-hook to the tow vehicle only. Do not connect breakaway cable S-hook to the safety cables or chains.
5. The breakaway system is designed to operate only after the trailer detaches from the tow vehicle and the safety cable/chains have disconnected from the tow vehicle. The breakaway is not a parking brake. Do not use as such.
6. **If the breakaway is accidentally applied while un-hitching, insert a flat bladed screwdriver into the slot on either side of the plastic cover on top of the actuator. The screw drive blade should go under the spring plate. Pry down on the handle of the screw driver to release the spring plate. The E-stop arm should fall back and down when released.**
7. Any control devices that restrict operation of the actuator cannot be used. This includes certain sway control devices. The actuator must be free to telescope in response to braking requirements.
8. Equalizing or weight distributing hitches may be used, allow six to eight inches free chain length. DANGER: Tongue weight outside rating limits will interfere with performance of actuator, and braking system, and the tow vehicle.
9. Automatic "Free-Backing" (backing-up without braking action) is possible with this Actuator when supplied with an electrically operated "Reverse Lock-Out Solenoid" or coupled with "Free-Backing" drum brakes. To allow "Free-Backing" without either of those components installed the Operator must manually "Lock-Out" the Actuator movement while backing up. This is accomplished by placing a 7/16 X 5" long bolt (or comparable screwdriver) through the upper hole provided through the actuator housing.

Danger: Failure to remove the bolt/screwdriver after backing will cause no braking action in normal use. Remember to always remove the bolt/screwdriver after backing the trailer.

10. **Important: The supplied, cable tethered, "Safety Pin" must be installed in the Coupler Latch hole (see illustration at right) during towing at all times.**

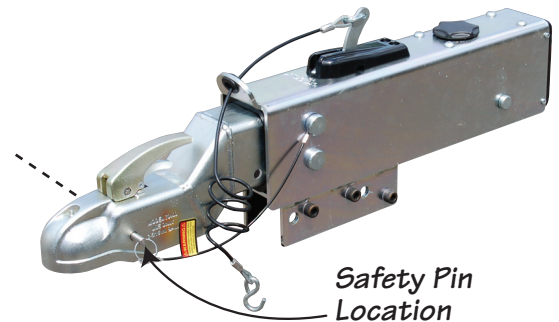

MAINTENANCE

1. Always check the brake fluid reservoir before using trailer. Make sure it is at least half full. If not, re-fill to approx. 3/8 inch below the top of the reservoir with DOT 3 brake fluid. Check for leaks and repair as required. Never reuse brake fluid.
2. To extend coupler and ball life, coat both with a thin coating of grease. This will also eliminate squeaking. Wipe clean and renew grease film each time trailer is used. A zerk fitting is installed on the coupler to make this step easier.
3. Examine the actuator for bent parts or wear each time the trailer is used. Replace parts as necessary.
4. There are no user adjustments on the actuator.
5. Excessive actuator travel may indicate a need to adjust the brakes or add fluid to the reservoir or a need to bleed the brakes and check connections for leaks. Adjust per instructions found in brake installation manual. In general, back off the adjusters on drum brakes from locked position, as required. Adjust Free-Backing brakes by rotating wheel in forward direction only. Failure to adjust may result in loss of braking. Disc brakes do not require adjustment, check for pad wear periodically.
6. While towing, if the actuator appears to be knocking against the hitch ball while starting or stopping, check brake fluid reservoir and fill if below 3/8" full from the top.

WARNING - DISC BRAKE USE

Actuator models designed for disc brakes do not have a “check valve” installed. Check valves are required for use with drum brakes. **DO NOT use any actuator designed for drum brakes on a trailer with disc brakes installed.**

WARNING

Actuator and brakes should always be flushed on the exterior with fresh water after using trailer in corrosive conditions. This includes salt water, fertilizers and other corrosive materials. Before storing trailer remove brakes and clean thoroughly. It is also wise to repack the bearings at the same time. Failure to properly and adequately maintain the actuator could cause serious damage, injury or death.

WARNING

The breakaway system is not designed to operate if the trailer does not separate completely from the tow vehicle, or if the tongue goes under the rear of the tow vehicle.

WARNING

In the event that the breakaway system is used, check all system components (cable, S-hooks, etc.) for proper working order. Replace any damaged parts with genuine Tie Down parts only.

WARNING

When re-setting the break away system keep hands and fingers clear as you re-set the mechanism, hydraulic pressure held in the system may cause the assembly to snap back suddenly.

WARNING

AVOID sharp turns, which can cause the actuator to bind or jackknife against the tow vehicle or cause a bend in the tongue. Either can damage the actuator causing brake failure. AVOID towing trailer across large bumps or dips that may over stress the connection between the trailer and tow vehicle, as this could result in damage to the actuator.

WARNING

DO NOT REUSE BRAKE FLUID. Always use fresh DOT 3 brake fluid from a fresh container. Failure to maintain proper levels of fluid in the reservoir will cause brake failure. ***Never use silicone based brake fluids.***

WARNING

Failure to install the hitch pin before towing can result in accidental opening of the coupler hitch latch which can lead to the trailer coming off of the hitch ball causing serious damage, injury or death. If pin will not fit into the latch hole, the coupler is not attached properly. Re-set coupler on hitch ball.

WARNING

A minimum of 5% tongue weight and a maximum 10% tongue weight of the trailer GVWR must be positioned over the hitch ball. The Trailer tongue should be parallel to the ground. Too much weight can cause premature brake actuation and loss of control of the towing vehicle. Too little tongue weight can cause the trailer to fishtail, resulting in loss of control of the tow vehicle and trailer (total trailer weight GVWR includes weight of the trailer plus load).

WARNING

A loose fit between the coupler and hitch ball can cause the actuator and hitch ball to separate, causing serious damage, injury or death. Check coupler every time prior to towing and at each stop on long trips. Always make certain that coupler latch safety pin is securely installed into coupler latch.

WARNING

Brake laws sometimes are minimum standards. Tie Down Engineering strongly recommends brakes on all axles. Read your tow vehicles owner's manual on towing capacity and other towing recommendations before installing brakes or this actuator.

WARNING

Never allow the coupler latch safety pin to remain in the reverse lockout position hole. After reverse maneuvering, always insert coupler latch safety pin back into coupler latch. **FAILURE TO REMOVE SAFETY PIN FROM REVERSE LOCK OUT POSITION HOLE WILL PREVENT FORWARD MOVEMENT BREAKING THAT CAN RESULT IN SERIOUS PROPERTY DAMAGE, INJURY OR DEATH.**

Bleeding Brakes for the 145 Raptor Actuator

1. Secure trailer on level ground. Chock wheels and/or attach trailer to the tow vehicle to keep the trailer from moving during the bleeding process
2. **Tools Required** – one (1) medium to large size flat blade screw driver, one (1) 3/16" & (1) 5/32" hex key wrench, one (1) wrench to fit the bleeder valves on your brakes and brake fluid DOT 3. **Do not use silicone brake fluids.** This will cause seal damage and void your warranty.
3. Pictures 1 & 2 – using the hex key wrenches, remove the three (3) hex screws holding the top black plastic cover on top of the actuator.
4. Picture 3 – slide the rectangular metal E-stop spring catch rearward several inches.
5. Picture 4 – fill master cylinder reservoir with DOT 3 brake fluid. NEVER re-use brake fluid. Use only new DOT brake fluid. Never use silicone based brake fluids.
6. Picture 5 & 6 – Insert the flat blade screw driver in the Cable attachment loop, with the blade of the screw driver against the E-stop arm. Pull the handle forward to pump the master cylinder.
7. Repeat several times and hold to build pressure to bleed each of the brakes. Follow brake manufacturer's instructions for bleeding the brakes.
8. Check the master cylinder reservoir often. Do not allow the reservoir to empty. When bleeding is completed, fill reservoir to within 3/8" from the bottom of the threads. **DO NOT OVER FILL.**

See next page

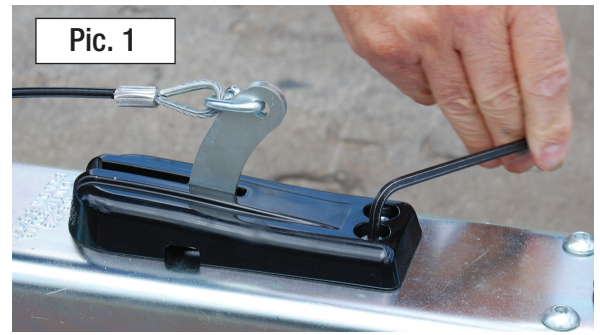

Bleeding Brakes for the 145 Raptor Actuator (Continued)

9. Reassemble E-stop spring latch and cover as shown in Pictures 7 thru 11. Slide the spring catch back into position so that the holes in the plate, line up with the holes in the cover. Place plastic cover over the plate, apply loc-tite or thread locker to threads and reinstall the three (3) hex head screws.

10. Test brakes in a protected area such as a parking lot or side street.

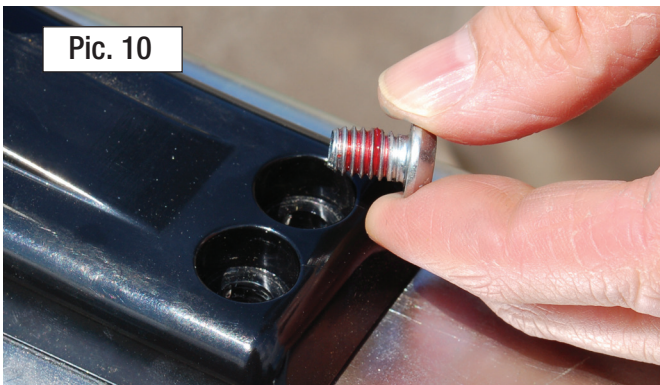
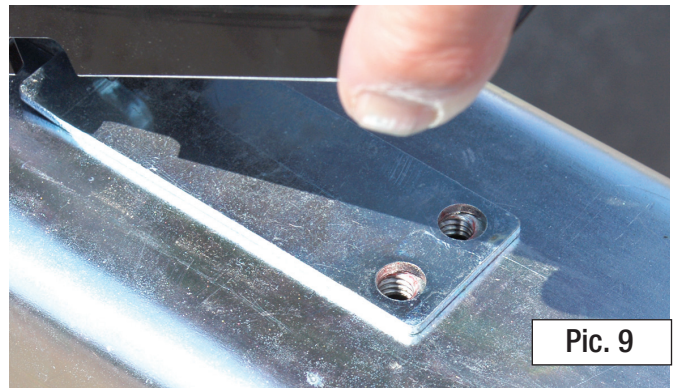
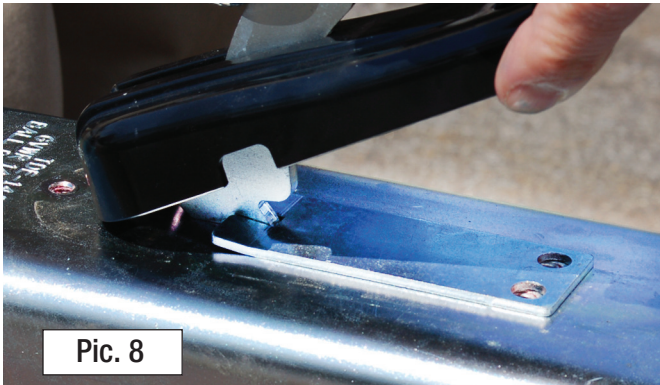

Emergency Stop Cable or E-stop Cable

The TDE 145 Raptor actuator is supplied with an emergency stop system that applies the brakes in the unlikely situation were the trailer becomes disconnected from the tow vehicle. The cable is PVC coated and coiled for convenience. On one end the cable is connected to a lever arm on top of the actuator. The other end of the cable has a hook to connect to the tow vehicle. Should the trailer become disconnected from the tow vehicle (both coupler and/or chains) the E-stop cable would pull the lever and activate the master cylinder. A steel spring lock keeps the pressure on the brakes until manually released.

1. When towing the vehicle, connect the end of the E-stop cable to the tow vehicle.
2. Never connect the E-stop cable to the safety chains or cables.
3. Connection point should be a position on the tow vehicle that is different from the safety cables or chains.

Continued on next page

WARNING: It is possible that the E-stop can be activated by pulling on the cable in various ways.

1. Forgetting to disconnect the E-stop cable from the tow vehicle and pulling tow vehicle away from the trailer. This would pull the lever and activate the brakes.
2. Stepping on the E-stop cable with enough force to pull the lever and activate the brakes.
3. Attaching the E-stop hook in a way that is too tight and causes the cable to be pulled when making turns while towing the trailer.
4. Wrapping the E-stop cable around the actuator or trailer tongue reducing the amount of free play in the cable.
5. Leaving the E-stop cable dragging on the ground, causing the cable to grab an object on the road.

RELEASING THE E-STOP

Always check the position of the E-stop lever to make sure it is not in a locked position. Lever should be able to touch the rear of the slot in the plastic cover when not activated.

1. Picture 1 shows a released E-stop lever position. Picture 2 shows an activated E-stop lever position.
2. To release, use a flat bladed screw driver to pry up the steel E-stop spring picture 3.
3. Insert flat bladed screwdriver under the steel spring plate and push the handle of the screw driver down, prying the spring plate up to release the E-stop lever. Picture 4.
4. E-stop lever should move freely after release picture 5.



Pic. 1

Normal Position

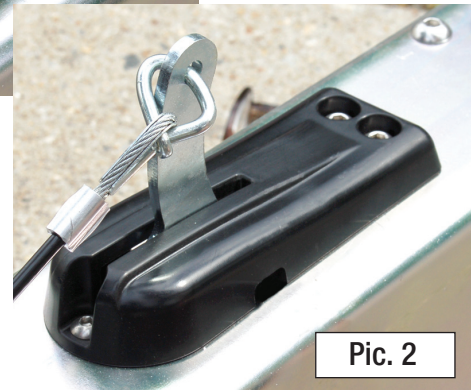

Brake "Engaged"

Pic. 2



Pic. 3

Place screwdriver head under the spring plate.

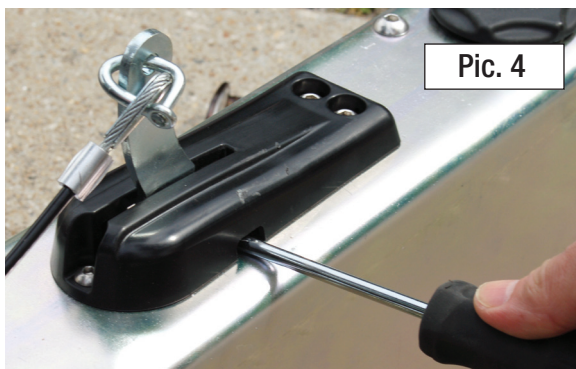

Pic. 4



Pic. 5



TIE DOWN ENGINEERING LIMITED ONE YEAR WARRANTY

Limited Warranty TIE DOWN ENGINEERING Inc ("TIE DOWN") warrants its products to be free from defects in material and workmanship for one year from date of delivery to the original purchaser when properly installed, used and maintained by the purchaser.

This warranty does not apply to damage or loss caused by any or all of the following circumstances or conditions:

- Damage caused during installation.
- Parts, accessories, materials or components used with or replacing any TIE DOWN braking system not obtained from or approved in writing by TIE DOWN.
- Misapplication, misuse and failure to follow the directions or observe cautions and warnings on installation, operation, application, inspection or maintenance specified in any TIE DOWN quotation, acknowledgement, sales literature, specification sheet or installation instruction and service manual ("applicable literature").
- Use of product in any other application other than those described in TIE DOWN's product information materials.

If any TIE DOWN products are found upon TIE DOWN's examination to have been defective when supplied, TIE DOWN will either: credit the purchaser's account for the purchase price of the TIE DOWN product; replace the TIE DOWN product; or repair the product. TIE DOWN has sole discretion in choosing which option to provide. For this LIMITED WARRANTY to apply, TIE DOWN must receive notice of the alleged defect within 30 days of either the discovery of the alleged defect or the expiration of the warranty period, whichever is earlier. Any claim not made within this period shall conclusively be deemed waived.

If requested by TIE DOWN, purchaser shall return the alleged defective product to TIE DOWN for examination at purchaser's expense. TIE DOWN will not pay for expenses incurred in returning a product to TIE DOWN without TIE DOWN's prior written authority. TIE DOWN shall not be liable for any other expenses purchaser incurs to remedy any defect. Purchasers waive subrogations on all claims under any insurance.

Limitation of Liability: It is expressly agreed that the liability of TIE DOWN is limited and TIE DOWN does not function as an insurer. THE REMEDIES SET FORTH IN THIS WARRANTY SHALL CONSTITUTE THE EXCLUSIVE REMEDIES AVAILABLE TO THE PURCHASER OR USER AND ARE IN LIEU OF ALL OTHER REMEDIES, EXPRESS OR IMPLIED. THE LIABILITY OF TIE DOWN, WHETHER IN CONTRACT, IN TORT, UNDER ANY WARRANTY OR OTHERWISE, SHALL NOT EXCEED THE PURCHASE PRICE OF THE PARTICULAR PRODUCT MANUFACTURED, SOLD OR SUPPLIED BY TIE DOWN.

To Obtain Technical Assistance: To enable TIE DOWN to respond to a request for assistance or evaluation of customer or user operating difficulty, please provide at a minimum the following information by calling 404-344-0000:

- Model number, serial number and all other data on the specific component which appears to be involved in the difficulty.
- The date and from whom you purchased your TIE DOWN product.
- State your difficulty, being sure to mention at least the following: Application, Nature of load involved, and Weight of the load.

Field Service: If field service at the request of the purchaser is rendered and the difficulty is found not to be with TIE DOWN's product, the purchaser shall pay the time and expense (at the prevailing rate at the time of service) of seller's field representative (s). Charges for service, labor and other expenses that have been incurred by the purchaser, its customer or agent without prior written authorization of TIE DOWN will not be accepted.

TIE DOWN EXTENDS NO WARRANTY, EXPRESS OR IMPLIED, ON PRODUCTS NOT MANUFACTURED BY TIE DOWN OR TO TIE DOWN'S DESIGN SPECIFICATION, INCLUDING BUT NOT LIMITED TO SUCH ITEMS AS TIRES, BRAKES, BEARINGS, HOSE AND TUBING. PURCHASER'S RECOURSE SHALL BE LIMITED TO ANY WARRANTY OF THE RESPECTIVE MANUFACTURERS.

THIS WARRANTY EXCLUDES ALL IMPLIED WARRANTIES OF MERCHANTABILITY OR FITNESS FOR A PARTICULAR PURPOSE OR ANY PURPOSE.

THIS WARRANTY DOES NOT COVER NOR EXTEND TO INCIDENTAL OR CONSEQUENTIAL DAMAGE. Some states do not allow the exclusion or limitation of incidental or consequential damages, so the above limitation or exclusion may not apply to you. This warranty gives you specific legal rights, and you may also have other rights which vary from state to state.

No representative has authority to make any representation, promise or agreement except as stated in this Limited Warranty. TIE DOWN reserves the right to make design and other changes upon its products without any obligation to install the same on any previously sold or delivered products.

DUE TO THE WIDE VARIATION IN USES TO WHICH TIE DOWN PRODUCTS (WHEELS, HUBS, BRAKES, ETC.) ARE SUBJECTED BY USERS, WE ARE UNABLE TO SPECIFY CARRYING CAPACITIES OR SPEEDS FOR A PARTICULAR APPLICATION. THEREFORE, THE MANUFACTURER MUST TEST HIS EQUIPMENT UNDER THE MOST SEVERE CONDITIONS TO DETERMINE THAT TIE DOWN PRODUCTS ARE SUITABLE.

THERE ARE NO WARRANTIES WHICH EXTEND BEYOND THOSE DESCRIBED ABOVE. EFFECTIVE JANUARY 2005 THIS WARRANTY SUPERSEDES ALL PRIOR WARRANTIES, WRITTEN OR IMPLIED.

“Raptor” Model 145 Part Detail

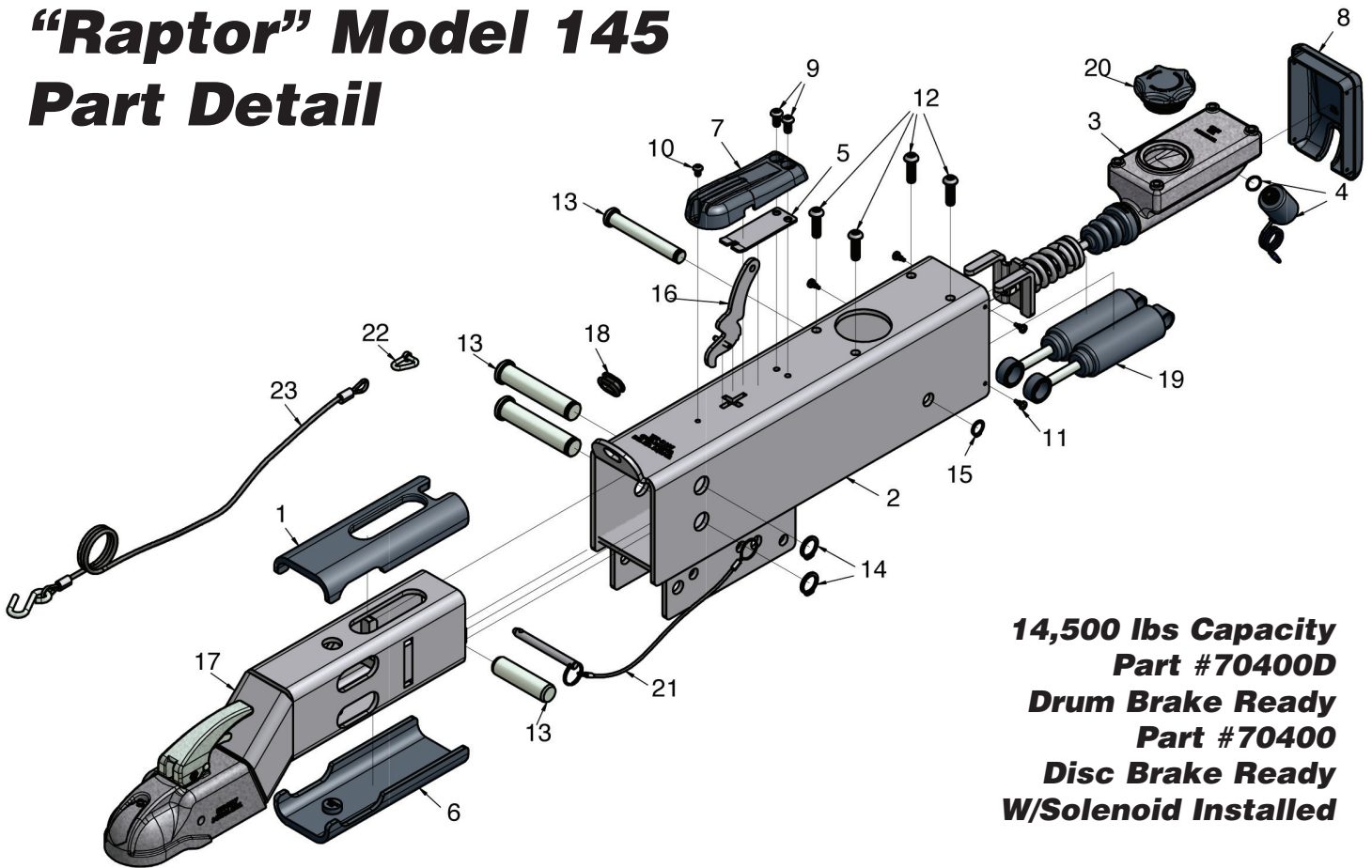

**14,500 lbs Capacity
Part #70400D
Drum Brake Ready
Part #70400
Disc Brake Ready
W/Solenoid Installed**

ITEM	QTY	PART #	DESCRIPTION
1	1	70404-1	UPPER WEAR PAD
2	1	70410	14.5K ACTUATOR HOUSING WELDMENT
3	1	70403	MASTER CYLINDER ASSEMBLY; 14,500 LB ACTUATOR - DISC BRAKE
4	1	11286	Valve Solenoid 2WNC Optional Back Flow
5	1	70405-2	E-STOP LEVER SPRING PLATE
6	1	70404-2	LOWER WEAR PAD
7	1	70405	E-STOP LEVER & SPRING COVER
8	1	70406	ACTUATOR HOUSING BACK COVER, 14,500 LB ACTUATOR
9	2	10893	SCREW SHBS 5/16-18X1/2 ZINC
10	1	10892	SCREW SHCS 1/4-20X3/8 ZINC
11	4	10889	SCREW PHPS 10-16X1/2 ZINC
12	4	10888	SCREW SHBS 3/8-16X1-1/4 ZINC
13	1	70408	ACTUATOR PIN KIT, 14,500 LB ACTUATOR
14	2	10886	RING RETAINING EXT SNAP 7/8 DIA SHAFT
15	1	10887	RING RETAINING EXT SNAP 5/8 DIA SHAFT
16	1	70407	E-STOP LEVER ASSEMBLY
17	1	70409	14.5 ACTUATOR/COUPLER ASSEMBLY
18	1	17422	GROMMET RUBBER 1.125 ODX5/8 IDX1/2 THICK
19	2	17028SA	DAMPER CYLINDER
20	1	48986A	MASTER CYLINDER CAP ASSEMBLY
21	1	50306	SAFETY PIN CABLE ASSEMBLY, 14,500 LB ACTUATOR
22	1	18457	LINK BEND CLOSE CONNECTOR 3/16
23	1	50307	EMERGENCY STOP CABLE ASSEMBLY, 14,500 LB ACTUATOR