

416
MODEL

POWER HOISTS

A=24
B=29
C=20
D=5
E=40
F=16
G=9

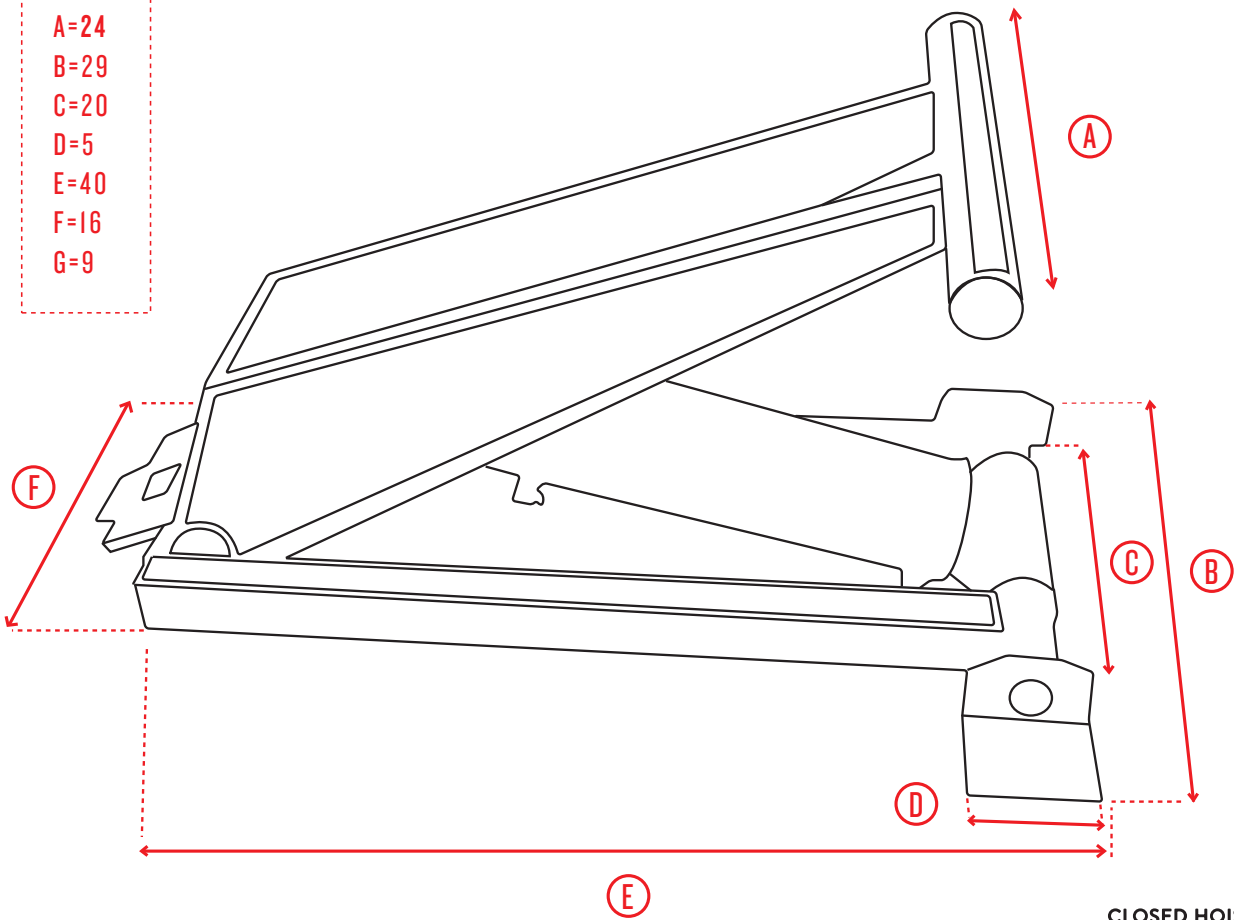

CLOSED HOIST

